

DIALOGO 360 WORKSTATION

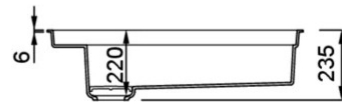

Disegno tecnico

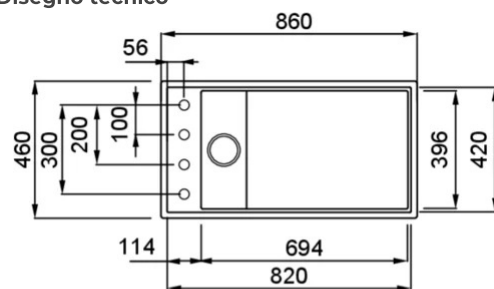

CARATTERISTICHE PRODOTTO

Descrizione	Lavello 1 vasca
Modello	DIALOGO 360 WORKSTATION
Base (mm)	900
Installazioni	Sopratop, Sottotop
Dimensioni (mm)	860 x 460
Foro da Incasso (mm)	850 x 450 R5 (Sopratop), 820 x 420 R4 (Sottotop)
Profondità Vasca (mm)	220

900

DATI LOGISTICI

Peso Lordo (kg)	14,60
Peso Netto (kg)	10,20
Dimensioni Imballo (kg)	940 x 575 x 300

CARATTERISTICHE IMBALLO

Imballo	Cartone e polietilene
----------------	-----------------------

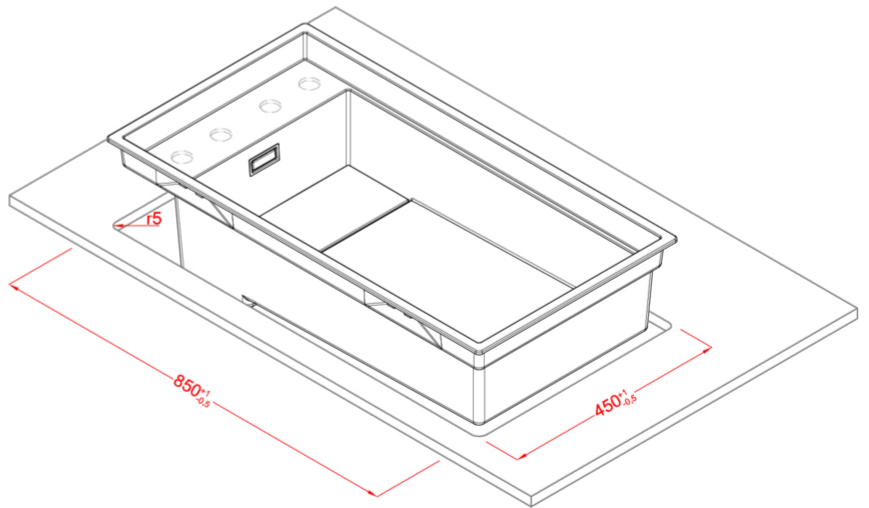
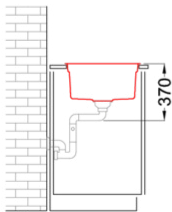
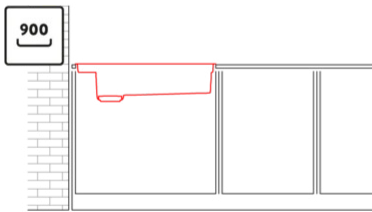
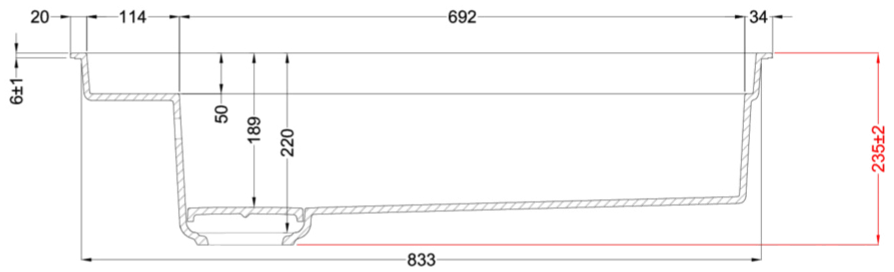
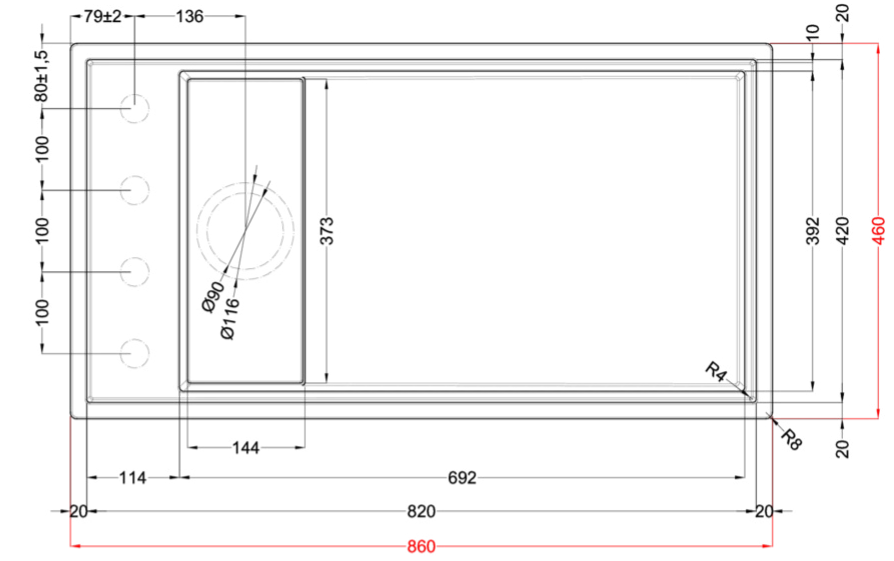
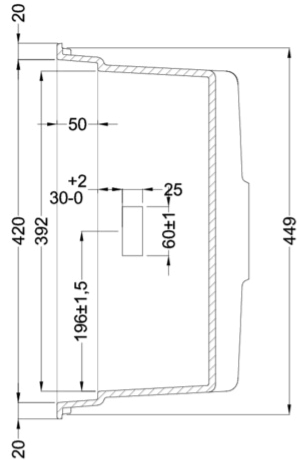

DIALOGO 360

general tolerances where not expressly communicated ±0.2%
connection dimensions according to UNI EN 695



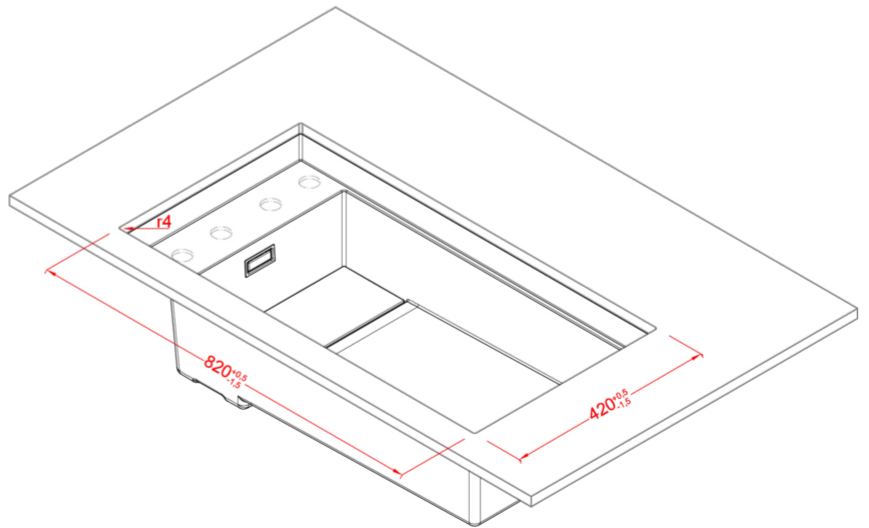
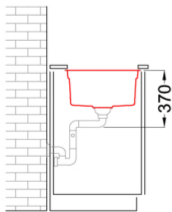
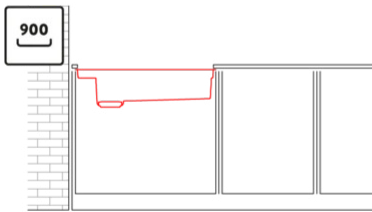
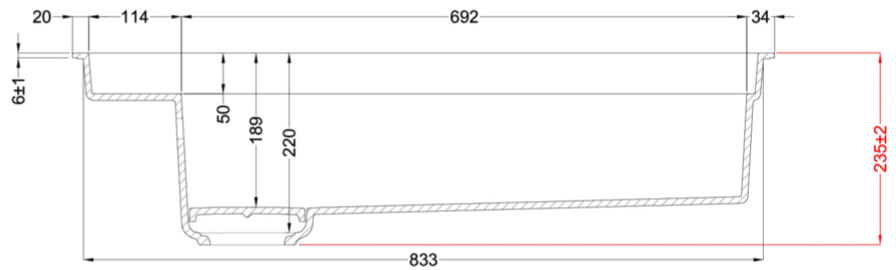
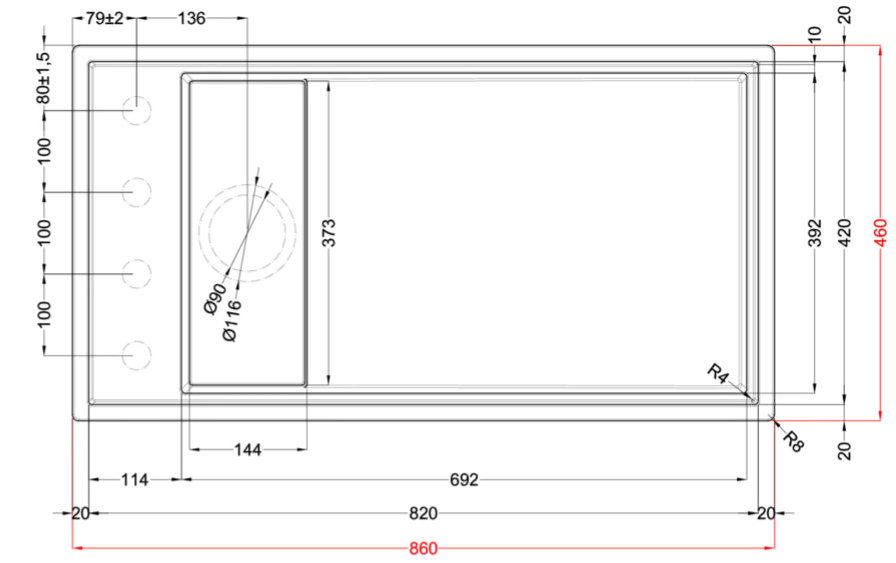
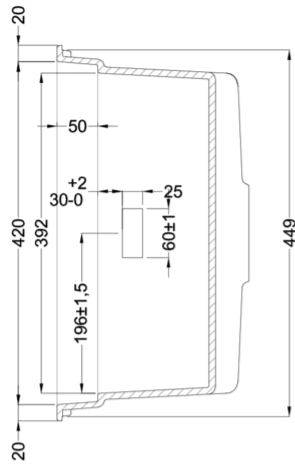

DIALOGO 360 UNDERMOUNT

general tolerances where not expressly communicated $\pm 0.2\%$
 connection dimensions according to UNI EN 695

