

KARISMA 105

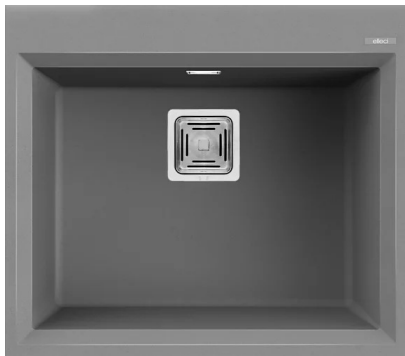

Disegno tecnico

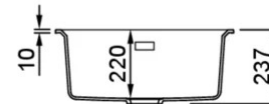
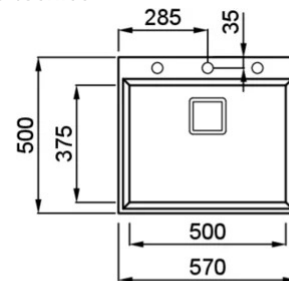

CARATTERISTICHE PRODOTTO

Descrizione	Lavello 1 vasca
Modello	KARISMA 105
Base (mm)	600
Installazioni	Sopratop
Dimensioni (mm)	570 x 500
Foro da Incasso (mm)	550 x 480
Numero Vasche	1
Profondità Vasca (mm)	220



DATI LOGISTICI

Peso Lordo (kg)	14,99
Peso Netto (kg)	9,50
Dimensioni Imballo (kg)	690 x 575 x 300
Volume Imballo (kg)	0,119

CARATTERISTICHE IMBALLO

Imballo	Cartone e polietilene
Corredi	Sifone salvaspazio, piletta quadrata, troppopieno rettangolare e ganci.

GRANITEK

METAL



LMK10573 M73
8032557957584



LMK10579 M79
8032557957607

GRANITEK

MATT



LGK10540 G40
8032557042365



LGK10543 G43
8032861044246



LGK10568 G68
8032557043348

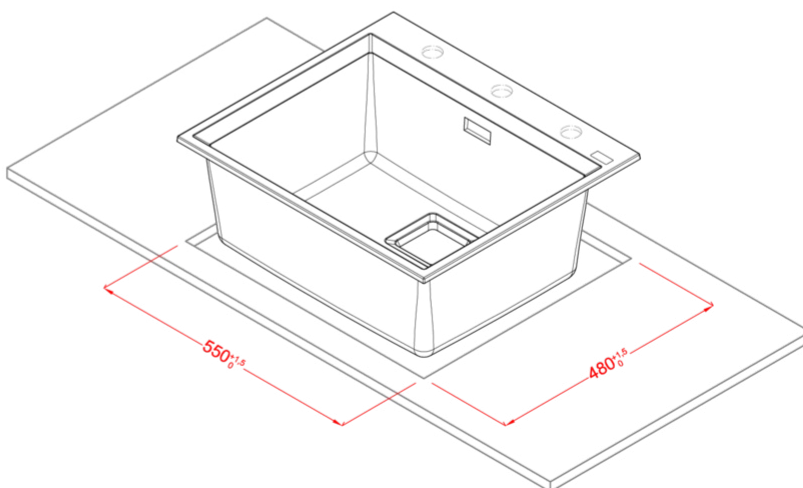
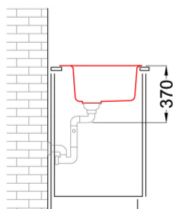
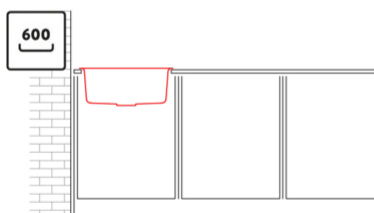
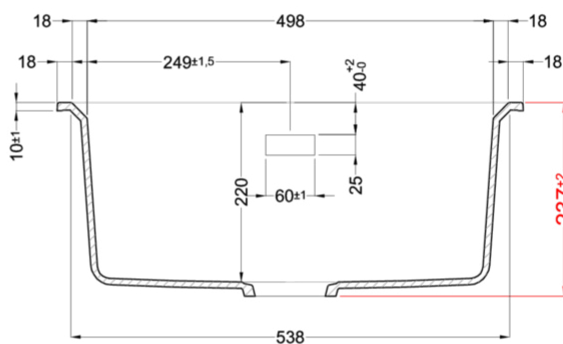
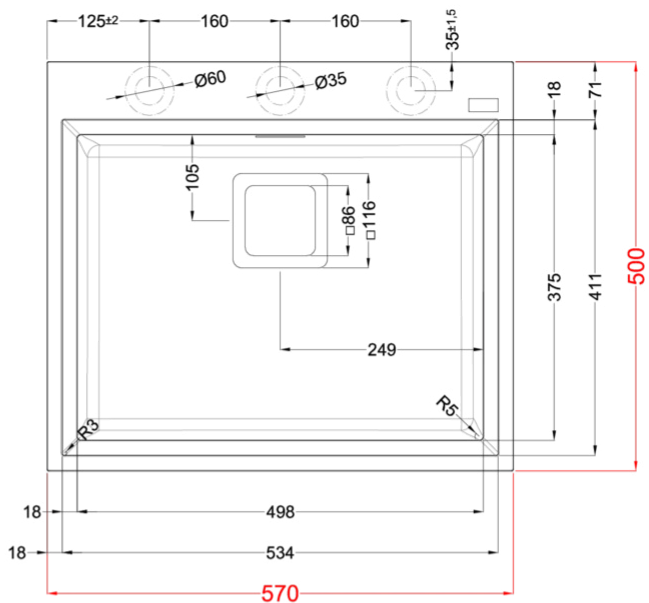
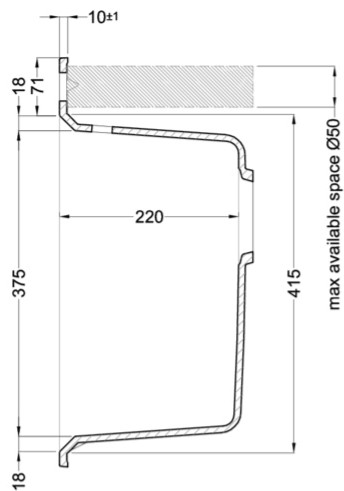

KARISMA 105

general tolerances where not expressly communicated ±0.2%
connection dimensions according to UNI EN 695

