

KARISMA 120

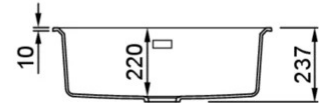

Disegno tecnico

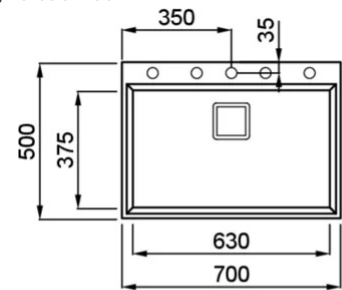

CARATTERISTICHE PRODOTTO

Descrizione	Lavello 1 vasca
Modello	KARISMA 120
Base (mm)	800
Installazioni	Sopratop
Dimensioni (mm)	700 x 500
Foro da Incasso (mm)	680 x 480
Numero Vasche	1
Profondità Vasca (mm)	220



DATI LOGISTICI

Peso Lordo (kg)	17,54
Peso Netto (kg)	11,90
Dimensioni Imballo (kg)	780 x 575 x 300
Volume Imballo (kg)	0,150

CARATTERISTICHE IMBALLO

Imballo	Cartone e polietilene
Corredi	Sifone salvaspazio, piletta quadrata, troppopieno rettangolare e ganci.

GRANITEK

METAL



LMK12073 M73
8032557956358



LMK12079 M79
8032557956372

GRANITEK

MATT



LGK12040 G40
8032557041726



LGK12043 G43
8032861042549



LGK12068 G68
8032557049319

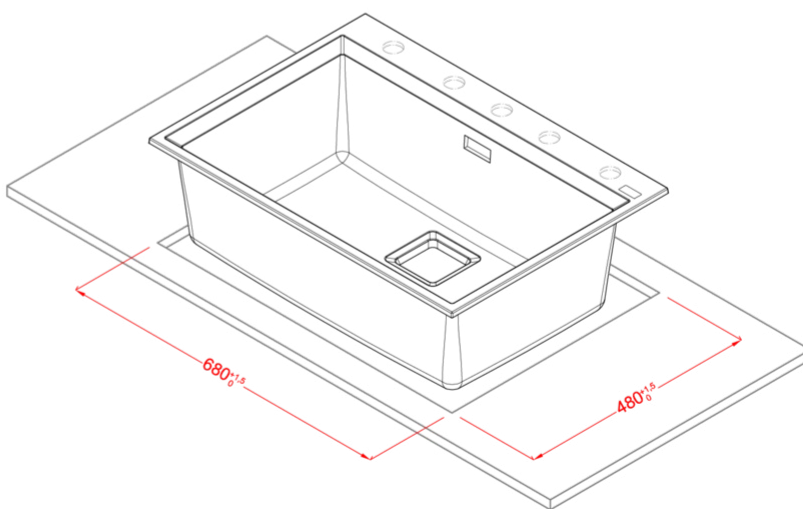
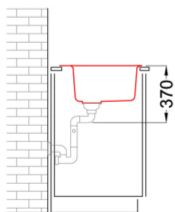
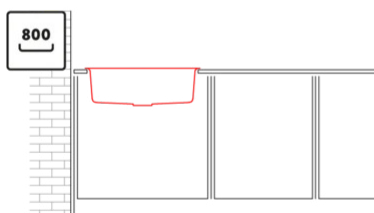
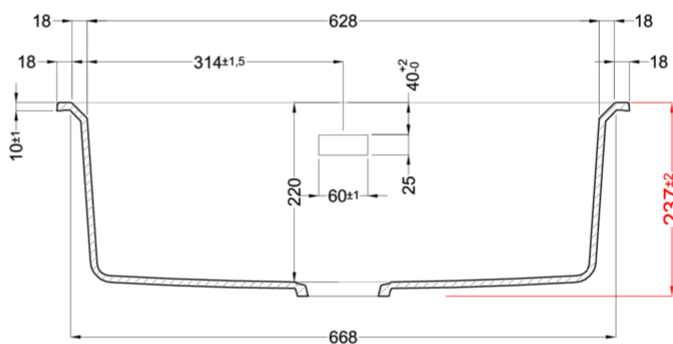
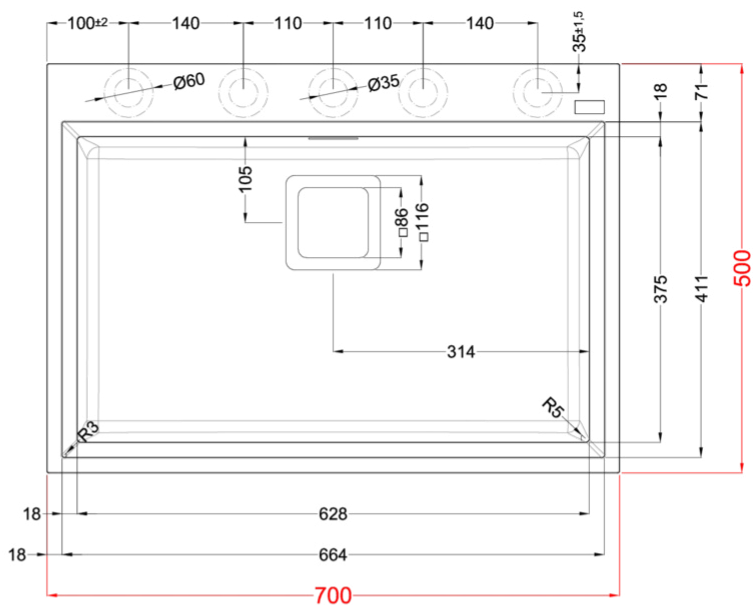
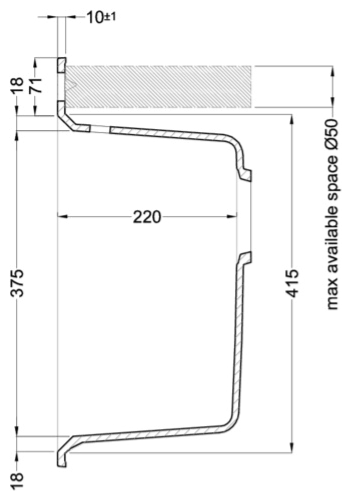

KARISMA 120

general tolerances where not expressly communicated $\pm 0.2\%$
connection dimensions according to UNI EN 695

