

QUADRA 102 SOTTOTOP

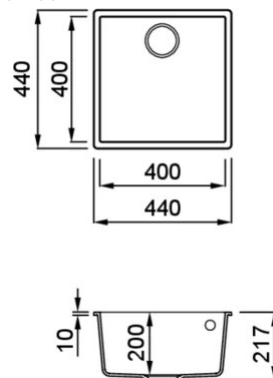

Disegno tecnico



CARATTERISTICHE PRODOTTO

Descrizione	Lavello 1 vasca
Modello	QUADRA 102 SOTTOTOP
Base (mm)	500
Installazioni	Sottotop
Dimensioni (mm)	440 x 440
Foro da Incasso (mm)	400 x 400 R5
Numero Vasche	1
Profondità Vasca (mm)	200



DATI LOGISTICI

Peso Lordo (kg)	11,56
Peso Netto (kg)	8,91
Dimensioni Imballo (kg)	575 x 575 x 300
Volume Imballo (kg)	0,099

CARATTERISTICHE IMBALLO

Imballo	Cartone e polietilene
Corredi	Sifone salvaspazio, troppopieno tondo, pilette e ganci.

KERATEK



LKQ10299BSO K99
8032557025924



LKQ10297BSO K97
8032557025917



LKQ10296BSO K96
8032557025900



LKQ10295BSO K95
8032557025894



LKQ10293BSO K93
8032557025887



LKQ10286BSO K86
8032557025870

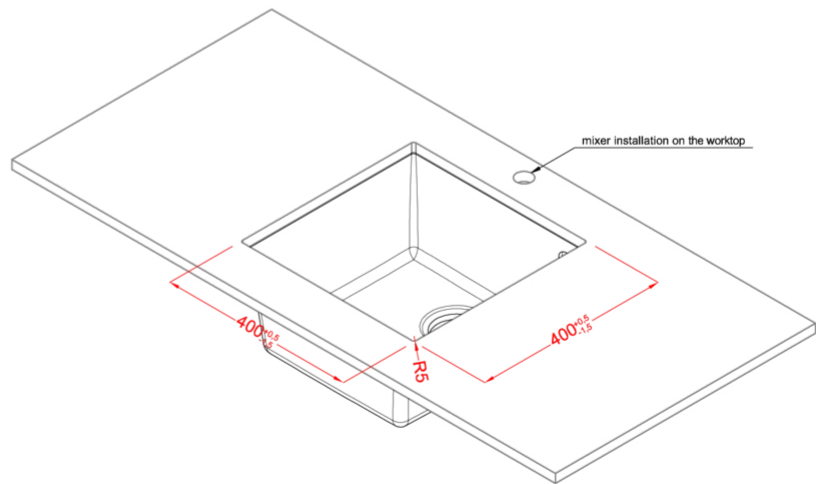
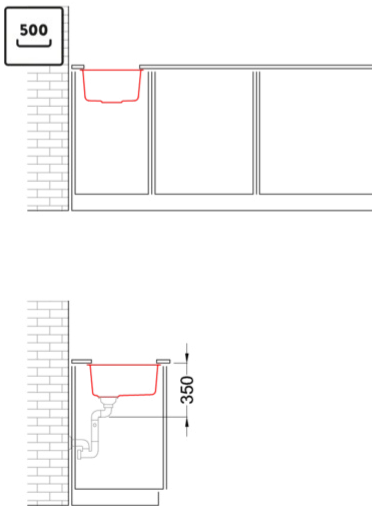
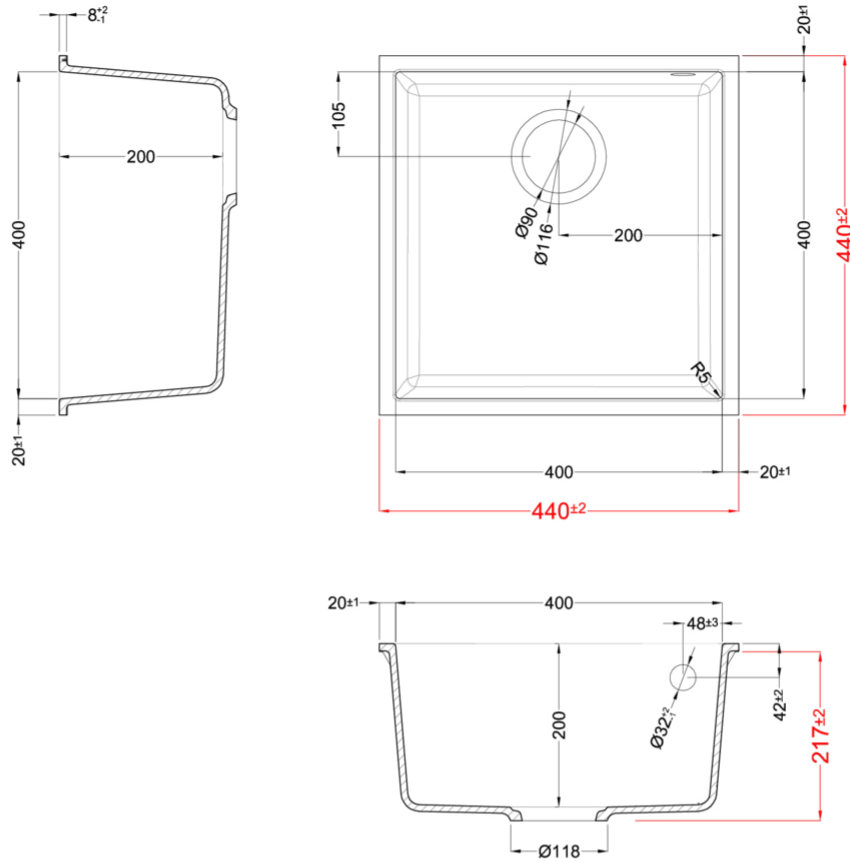

QUADRA 102 UNDERMOUNT

general tolerances where not expressly communicated $\pm 0.2\%$
connection dimensions according to UNI EN 695



