

BEST 130

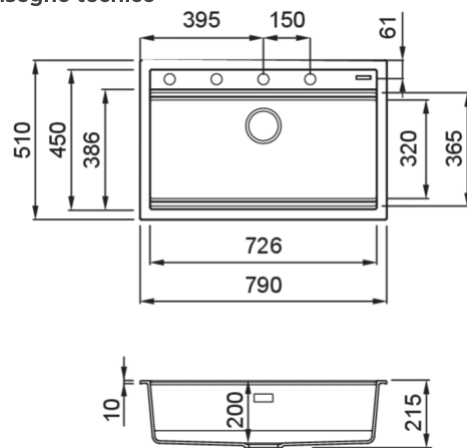

Disegno tecnico



CARATTERISTICHE PRODOTTO

Descrizione	Lavello 1 vasca
Modello	BEST 130
Base (mm)	800
Installazioni	Sopratop
Dimensioni (mm)	790 x 510
Foro da Incasso (mm)	770 x 480
Numero Vasche	1
Profondità Vasca (mm)	200



DATI LOGISTICI

Peso Lordo (kg)	18,85
Peso Netto (kg)	13,00
Dimensioni Imballo (kg)	870 x 575 x 300
Volume Imballo (kg)	0,150

CARATTERISTICHE IMBALLO

Imballo	Cartone e polietilene
Corredi	Sifone salvaspazio, piletta Flow Pro integrata, troppopieno rettangolare e ganci. Corredo del lavello Bundle: Colander, Drainer Flex, sifone salvaspazio, piletta Flow Pro integrata, troppopieno rettangolare e ganci.

KERATEK



LKB13086 K86
8032557027140



LKB13093 K93
8032557027157



LKB13095 K95
8032557027164



LKB13096 K96
8032557027171



LKB13097 K97
8032557027188



LKB13099 K99
8032557027195

GRANITEK

METAL



LMB13073 M73
8031873117450



LMB13079 M79
8031873117474

GRANITEK

MATT



LGB13040 G40
8031873069278



LGB13043 G43
8031873069285



LGB13048 G48
8031873069292



LGB13068 G68
8031873069339

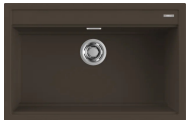

LGB13078 G78
8032557066873

GRANITEK

CLASSIC



LGB13051 G51
8031873069308



LGB13059 G59
8031873069315



LGB13062 G62
8031873069322

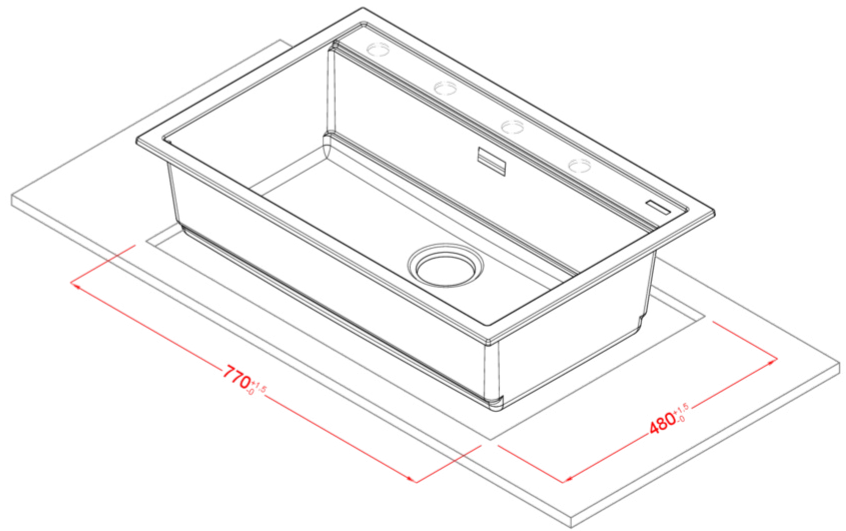
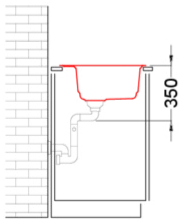
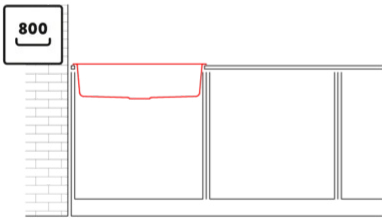
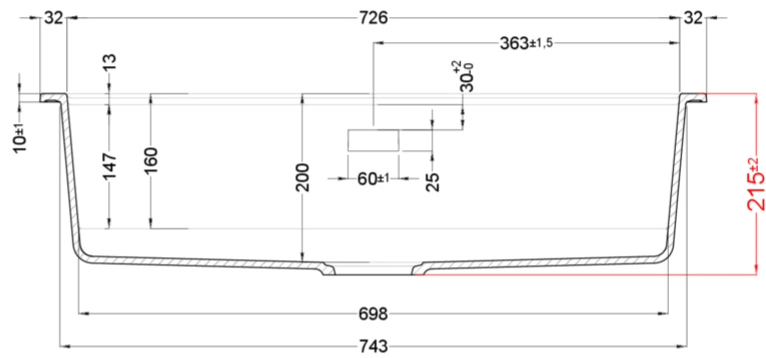
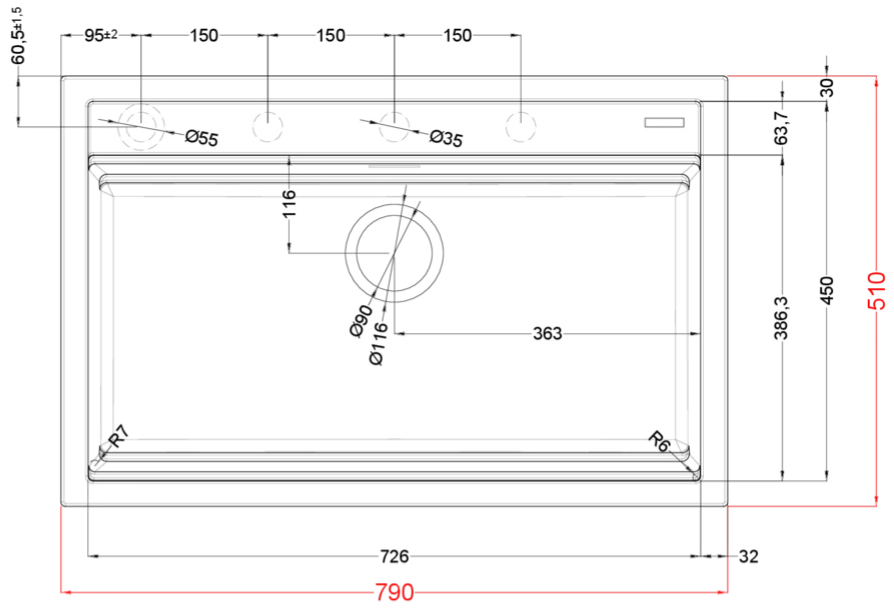
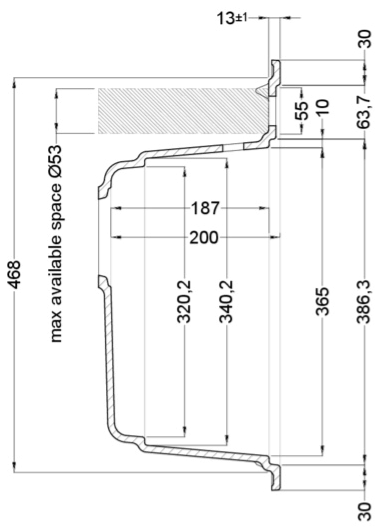

Best 130

general tolerances where not expressly communicated ±1 mm
 connection dimensions according to UNI EN 695
 eventual exceptions are reported with *

elleci