

BEST 475

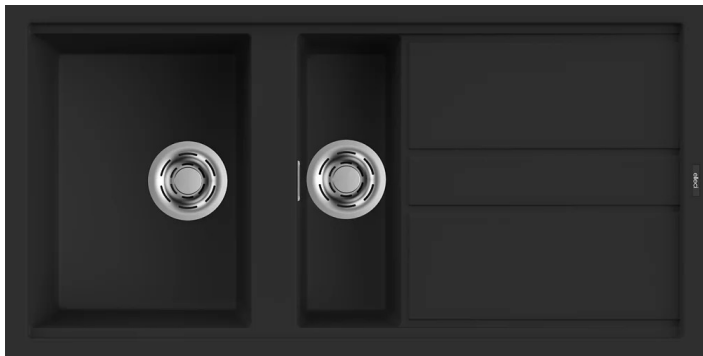

Technical Drawing

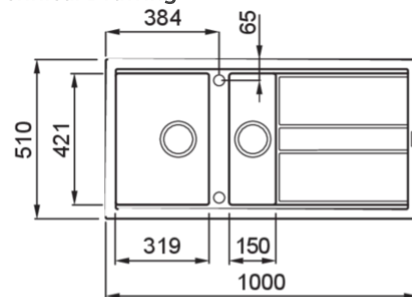

0	
Description	1½-bowl sink with drainer
Model	BEST 475
Base (mm)	600
0	Inset
Dimensions (mm)	1000 x 510
Hole for built-in installation (mm)	980 x 480
Number of Bowls	1.5
0	
Gross Weight (kg)	20,50
Net Weight (kg)	13,90
Packaging Dimension (kg)	1080 x 575 x 300
0 (kg)	0,186
0	
Packaging	Cardboard and polyethylene
0	Space-saving siphon, integrated Flow Pro, rectangular overflow and hooks.

KERATEK



LKB47586 K86
8031873020200



LKB47593 K93
8031873026585



LKB47595 K95
8031873026592



LKB47596 K96
8031873020217



LKB47597 K97
8031873026608

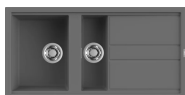

LKB47599 K99
8031873026615

GRANITEK

METAL



LMB47573 M73
8032861953760



LMB47579 M79
8032861953777

GRANITEK

MATT



LGB47540 G40
8032861045731



LGB47543 G43
8032861043607



LGB47548 G48
8032557030782



LGB47568 G68
8032861048985

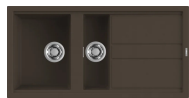

LGB47578 G78
8032557066941

GRANITEK

CLASSIC



LGB47551 G51
8032861043553



LGB47559 G59
8032861043546



LGB47562 G62
8032861048978

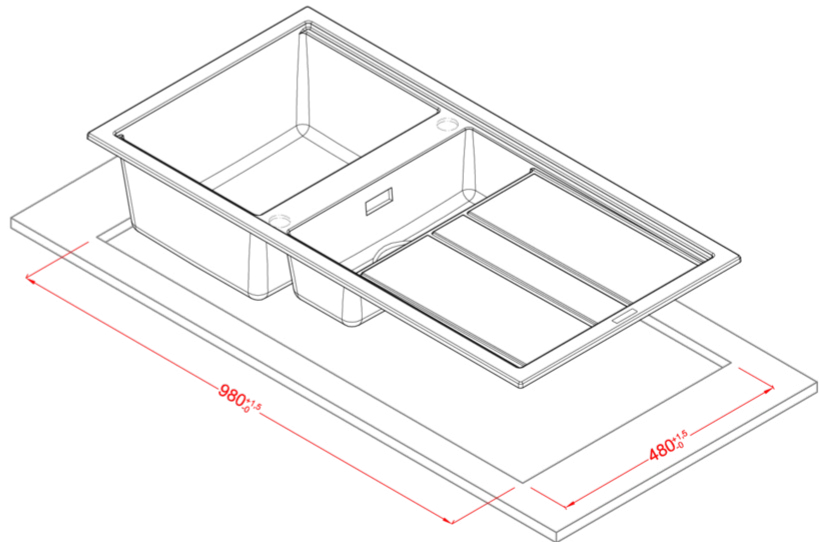
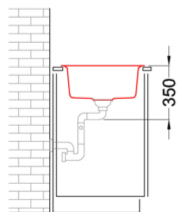
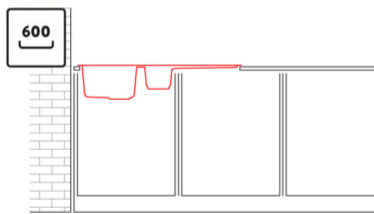
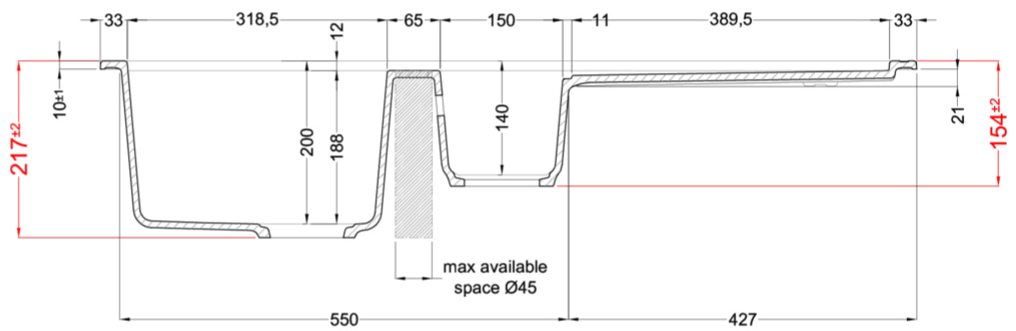
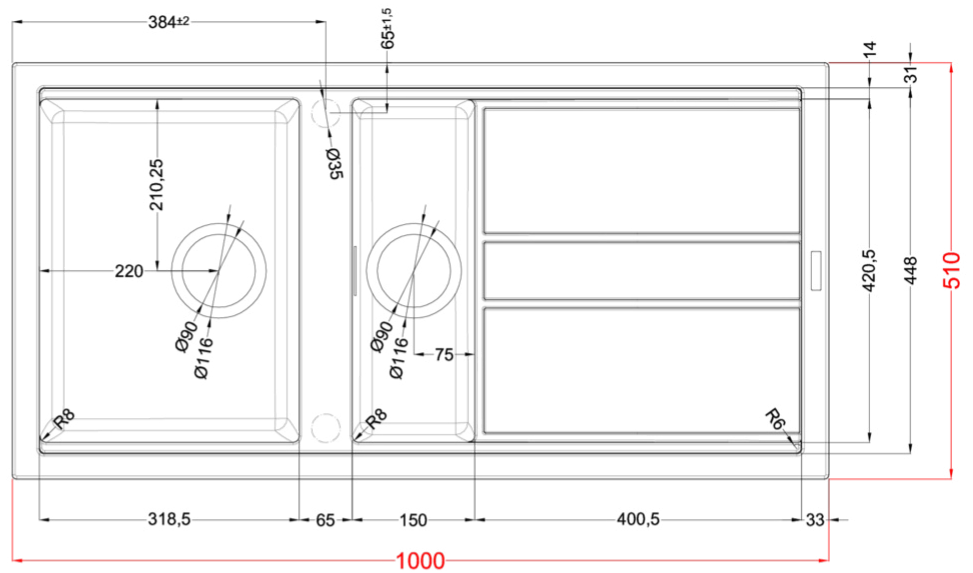
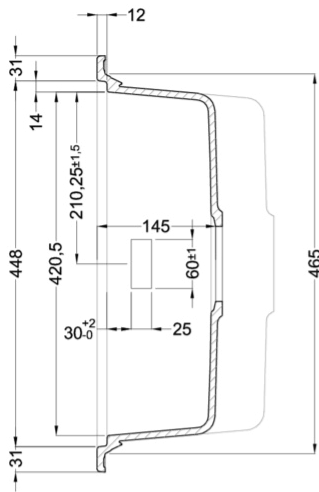

BEST 475

general tolerances where not expressly communicated $\pm 0.2\%$
 connection dimensions according to UNI EN 695

