

## BEST 475

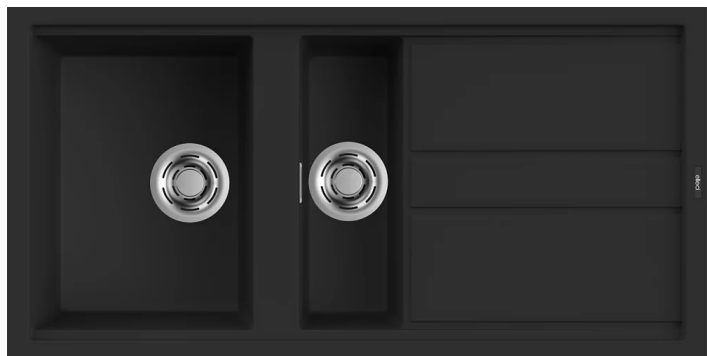

### CARATTERISTICHE PRODOTTO

<b>Descrizione</b>	Lavello 1 vasca ½ con gocciolatoio
<b>Modello</b>	BEST 475
<b>Base (mm)</b>	600
<b>Installazioni</b>	Sopratop
<b>Dimensioni (mm)</b>	1000 x 510
<b>Foro da Incasso (mm)</b>	980 x 480
<b>Numero Vasche</b>	1,5

### DATI LOGISTICI

<b>Peso Lordo (kg)</b>	20,50
<b>Peso Netto (kg)</b>	13,90
<b>Dimensioni Imballo (kg)</b>	1080 x 575 x 300
<b>Volume Imballo (kg)</b>	0,186

### CARATTERISTICHE IMBALLO

<b>Imballo</b>	Cartone e polietilene
<b>Corredi</b>	Sifone salvaspazio, piletta Flow Pro integrata, troppopieno rettangolare e ganci.

### Disegno tecnico

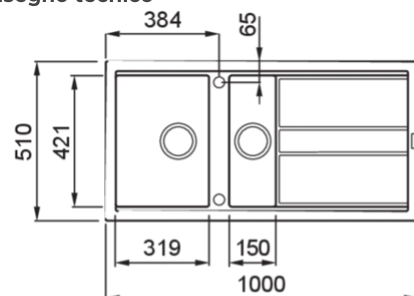

## KERATEK



**LKB47586** K86  
8031873020200



**LKB47593** K93  
8031873026585



**LKB47595** K95  
8031873026592



**LKB47596** K96  
8031873020217



**LKB47597** K97  
8031873026608



**LKB47599** K99  
8031873026615

## GRANITEK

### METAL



**LMB47573** M73  
8032861953760



**LMB47579** M79  
8032861953777

# GRANITEK

## MATT



**LGB47540** G40  
8032861045731



**LGB47543** G43  
8032861043607



**LGB47548** G48  
8032557030782



**LGB47568** G68  
8032861048985

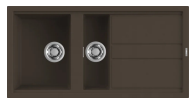

**LGB47578** G78  
8032557066941

# GRANITEK

## CLASSIC



**LGB47551** G51  
8032861043553



**LGB47559** G59  
8032861043546



**LGB47562** G62  
8032861048978

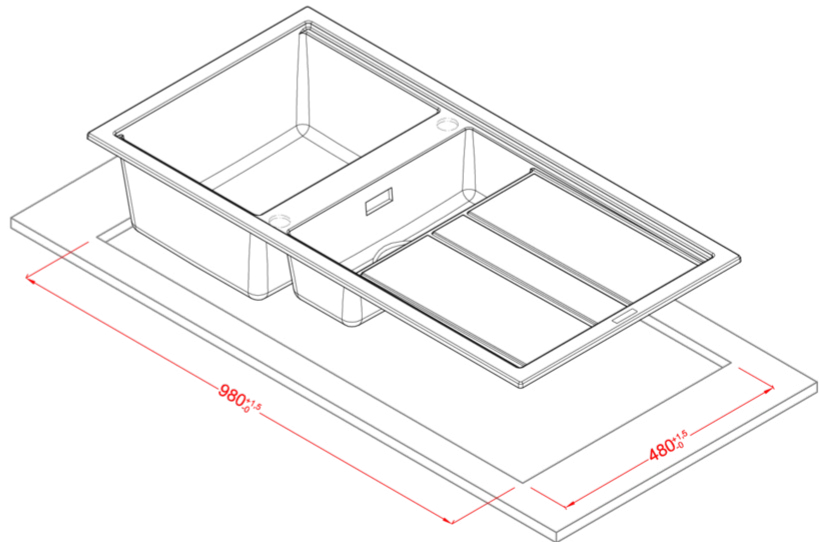
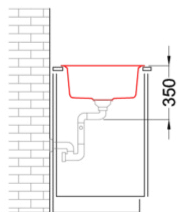
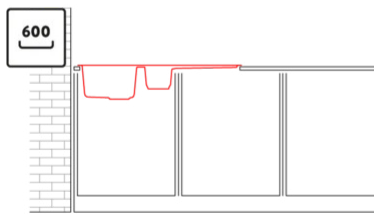
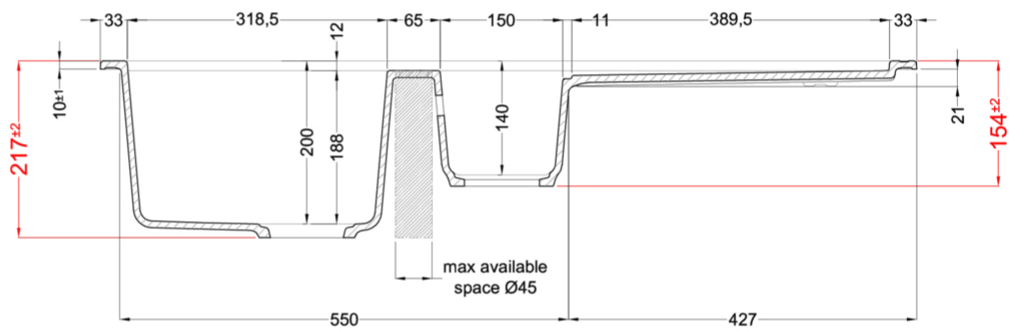
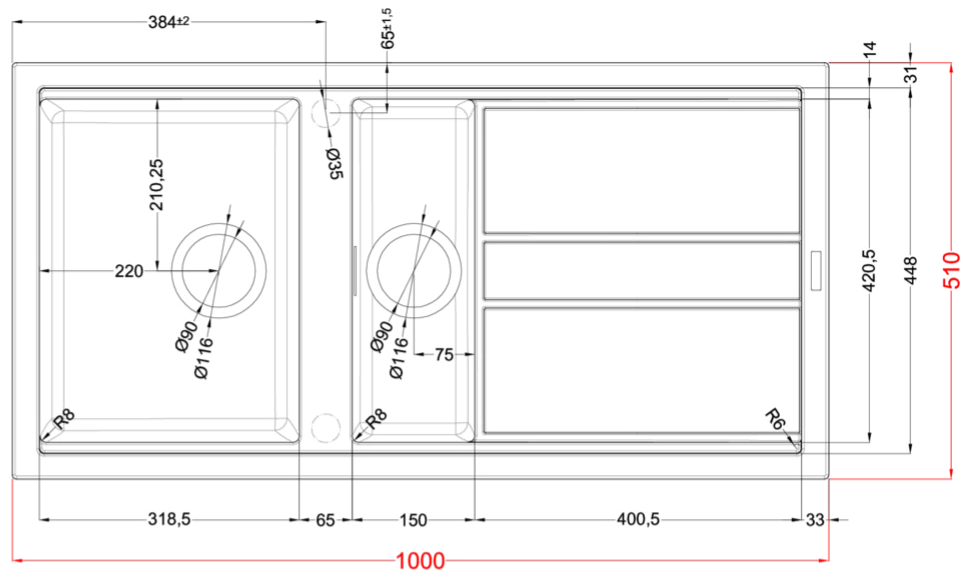
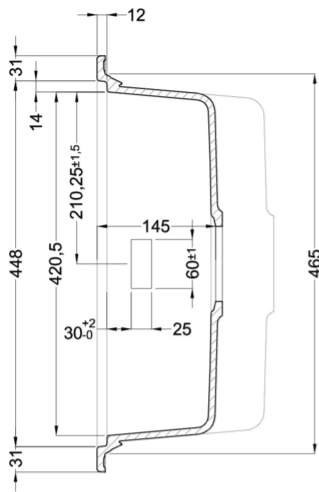

## BEST 475

general tolerances where not expressly communicated ±0.2%  
connection dimensions according to UNI EN 695

