

# DIALOGO 360 WORKSTATION

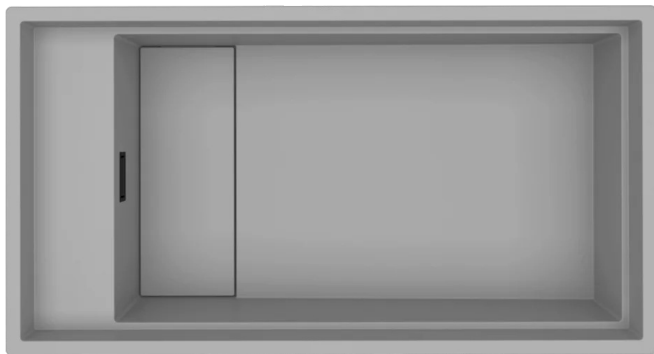

## Technical Drawing

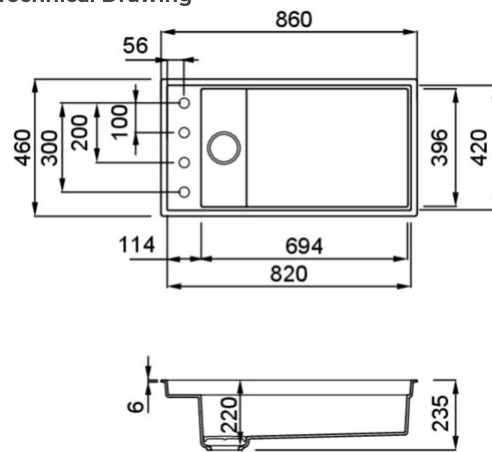

0

<b>Description</b>	1-bowl sink
<b>Model</b>	DIALOGO 360 WORKSTATION
<b>Base (mm)</b>	900
<b>0</b>	Inset, Undermount Undermount
<b>Dimensions (mm)</b>	860 x 460
<b>Hole for built-in installation (mm)</b>	850 x 450 R5 (Inset), 820 x 420 R4 (Undermount)
<b>Bowl Depth (mm)</b>	220

900

0

<b>Gross Weight (kg)</b>	14,60
<b>Net Weight (kg)</b>	10,20
<b>Packaging Dimension (kg)</b>	940 x 575 x 300

0

<b>Packaging</b>	Cardboard and polyethylene
------------------	----------------------------

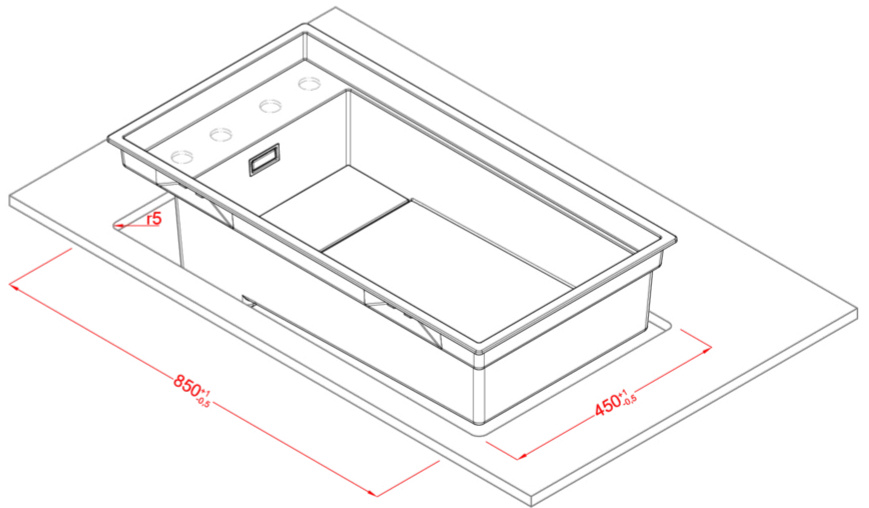
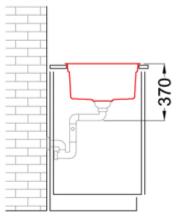
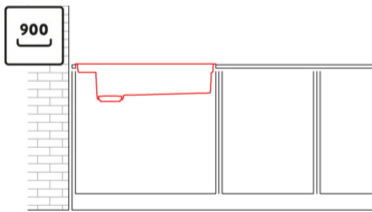
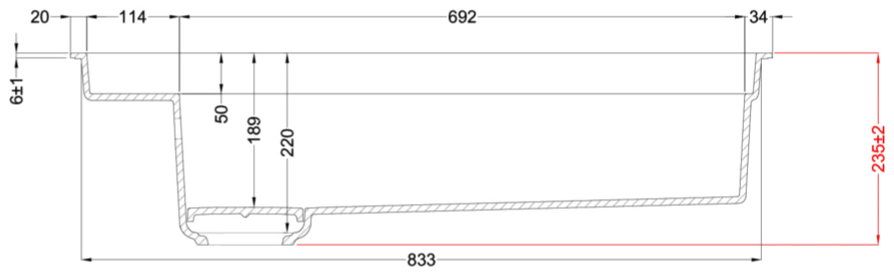
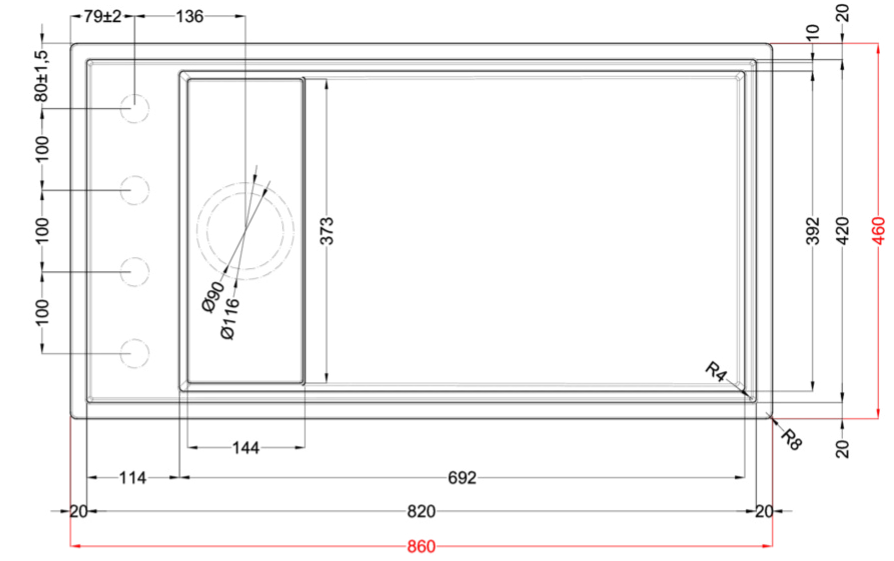
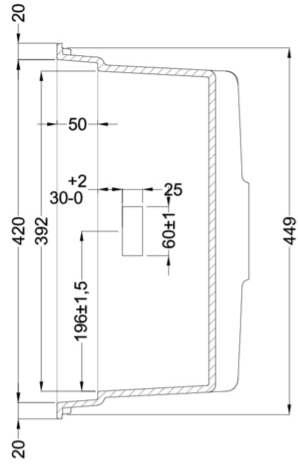

# DIALOGO 360

general tolerances where not expressly communicated  $\pm 0.2\%$   
 connection dimensions according to UNI EN 695



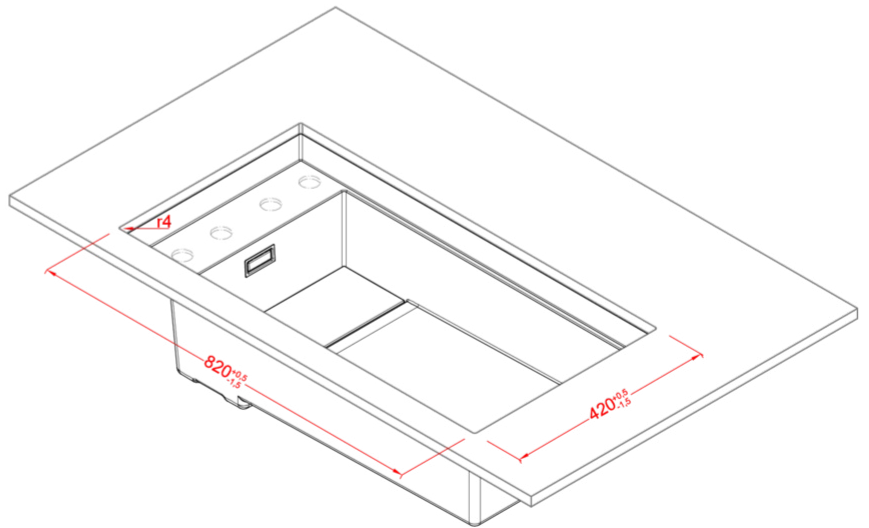
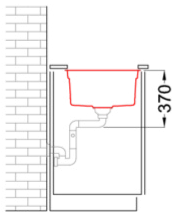
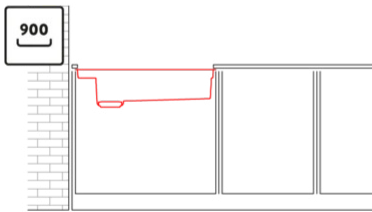
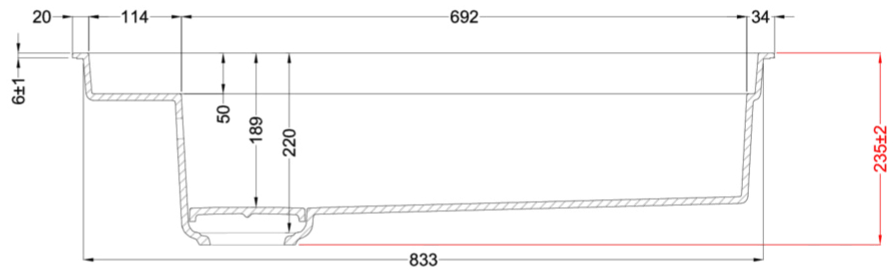
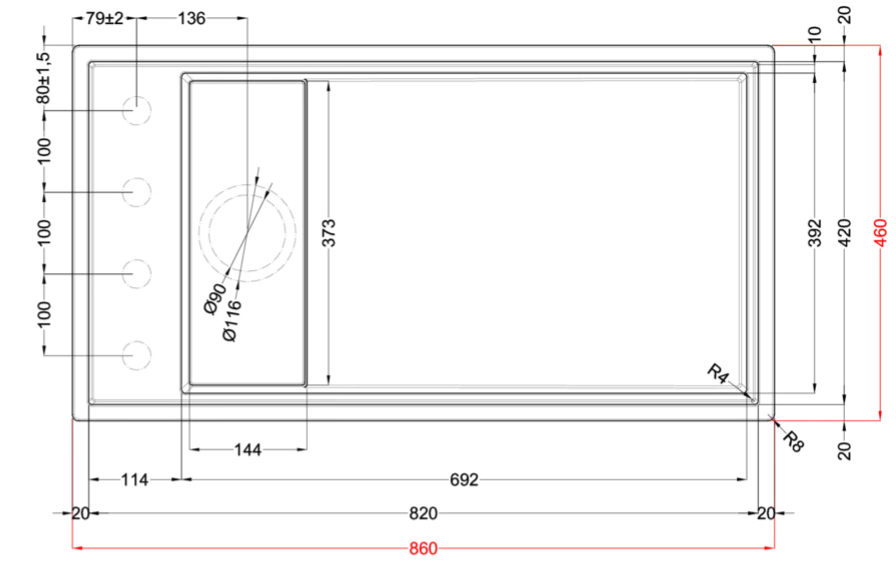
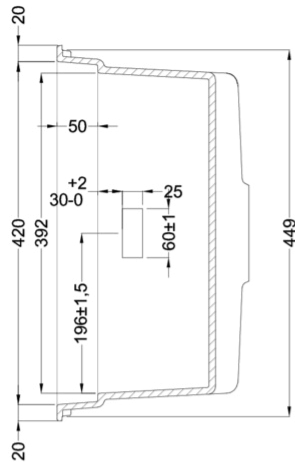

# DIALOGO 360 UNDERMOUNT

general tolerances where not expressly communicated  $\pm 0.2\%$   
 connection dimensions according to UNI EN 695

