

## EASY 135

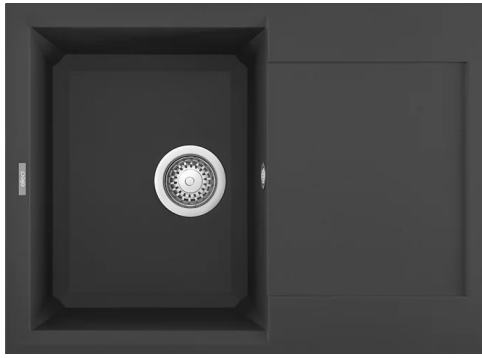

### Technical Drawing

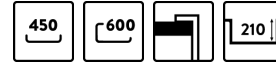
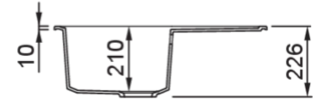
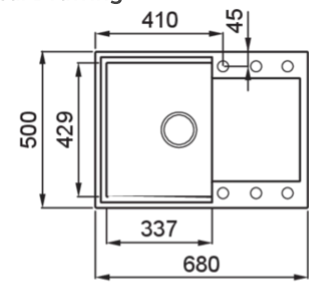

0

<b>Description</b>	1-bowl sink with drainer
<b>Model</b>	EASY 135
<b>Base (mm)</b>	450     600 if first component
<b>0</b>	Inset
<b>Dimensions (mm)</b>	680 x 500
<b>Hole for built-in installation (mm)</b>	660 x 480
<b>Number of Bowls</b>	1
<b>Bowl Depth (mm)</b>	210

0

<b>Gross Weight (kg)</b>	15,04
<b>Net Weight (kg)</b>	9,80
<b>Packaging Dimension (kg)</b>	780 x 575 x 300
<b>0 (kg)</b>	0,135

0

<b>Packaging</b>	Cardboard and polyethylene
<b>0</b>	Space-saving siphon, wastes and hooks.

# GRANITEK

METAL

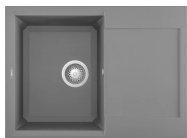

**LMY13573 M73**  
8032557957683



**LMY13579 M79**  
8032557957706

# GRANITEK

## MATT

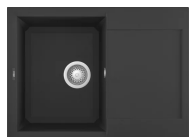

**LGY13540** G40  
8032557043096

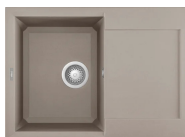

**LGY13543** G43  
8032557046134



**LGY13548** G48  
8032557031222



**LGY13568** G68  
8032557043966

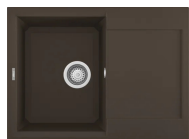

**LGY13578** G78  
8032557067337

# GRANITEK

## CLASSIC

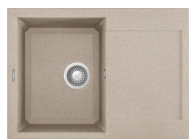

**LGY13551** G51  
8032557048398



**LGY13559** G59  
8032557042044

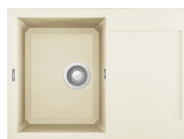

**LGY13562** G62  
8032557042037

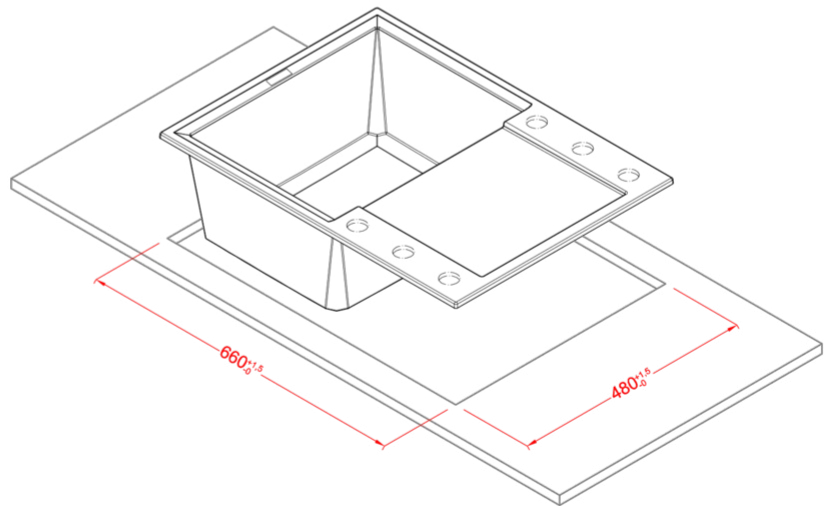
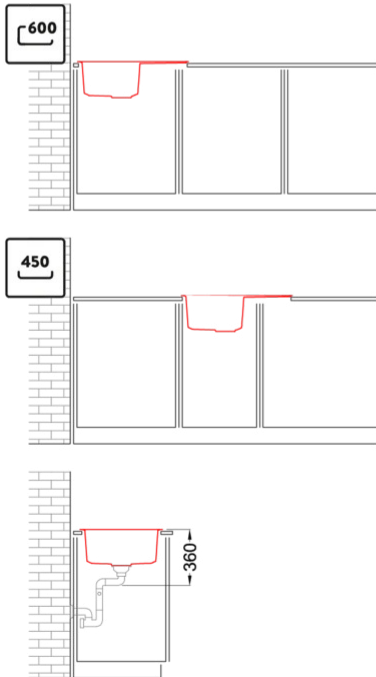
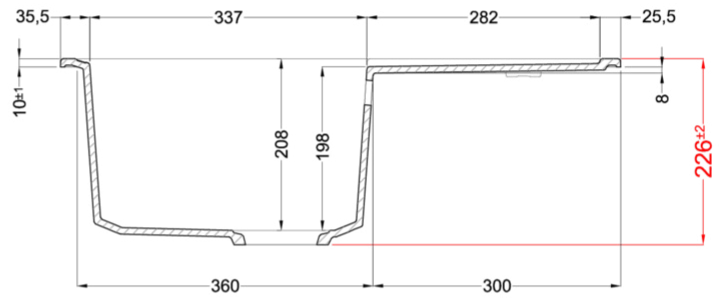
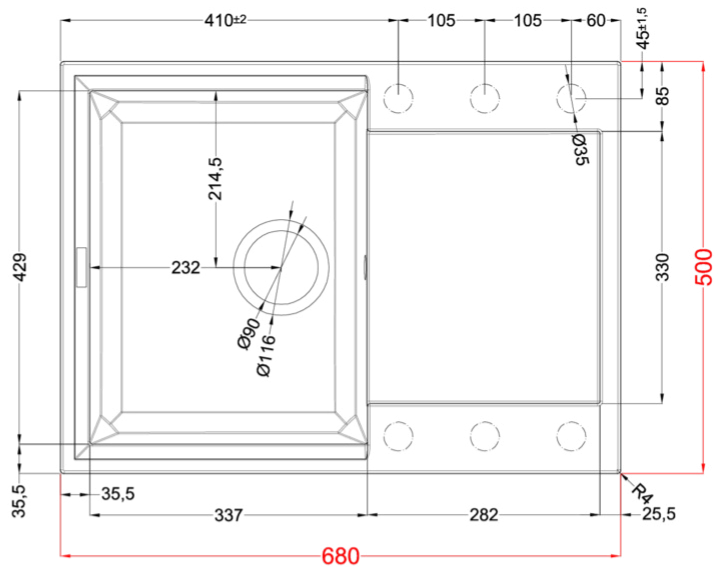
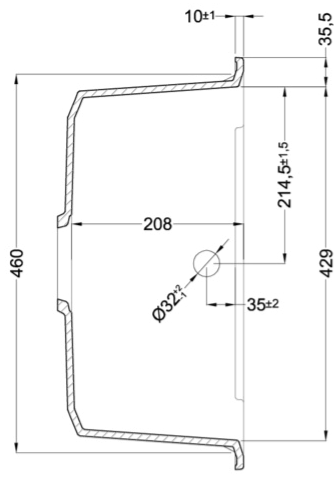

# Easy 135

general tolerances where not expressly communicated  $\pm 1$  mm  
 connection dimensions according to UNI EN 695  
 eventual exceptions are reported with \*

