

INTENSO QUADRO 48

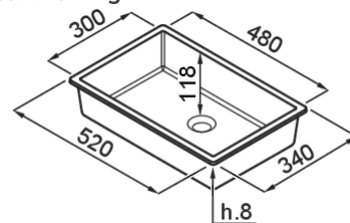

Technical Drawing



FEATURES

Description	1-bowl washbasin
Model	INTENSO QUADRO 48
Installations	Undermount, Inset, Integrated
Dimensions (mm)	520 x 340
Hole for built-in installation (mm)	480x300
Number of Bowls	1
Bowl Depth (mm)	130

DURATEK



BDIQU048BK30 BLACK
8031873764432



BDIQU048WH30 WHITE
8031873764449



BDIQU048GR30 GREY
8031873764456



BDIQU048CA30
8031873010874

BDIQU048SG30 SAGE GREEN
8031873009038

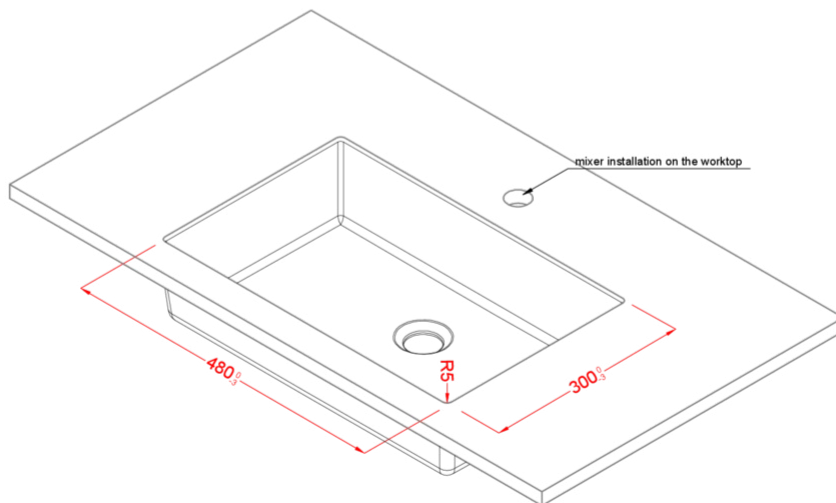
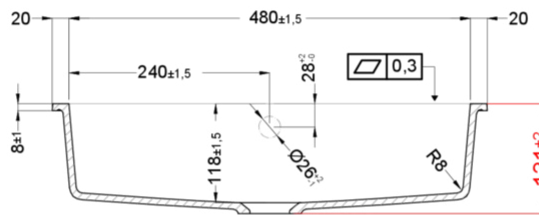
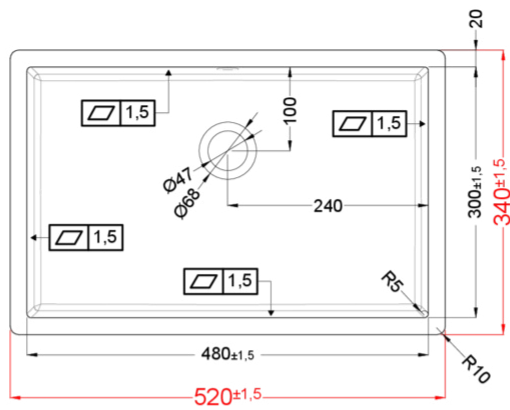

INTENSO QUADRO 48 INTEGRATED

general tolerances where not expressly communicated $\pm 0.2\%$
 connection dimensions according to UNI EN 31

